



**GDM  
LINDEX**

The Courtyard, Long Row, Newark, Notts NG24 1RW, ENGLAND

Telephone: +44 (0) 1636 610030 Fax : +44(0) 1636 610022

E-mail : [sales@gdmlindex.co.uk](mailto:sales@gdmlindex.co.uk) Website: [www.gdmlindex.co.uk](http://www.gdmlindex.co.uk)

## Ventilation Grilles





The Courtyard, Long Row, Newark, Notts NG24 1RW, ENGLAND

Telephone: +44 (0) 1636 610030 Fax : +44(0) 1636 610022

E-mail : [sales@gdmlindex.co.uk](mailto:sales@gdmlindex.co.uk) Website: [www.gdmlindex.co.uk](http://www.gdmlindex.co.uk)

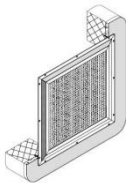

**CS0701 - Surface Mounted Vent Grille**  
(Price on application)

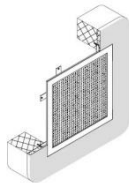

**CS0702 - Flush Mounted Vent Grille**  
(Price on application)

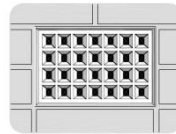

**CS0703 - Cast Iron Air Brick**  
£25.00

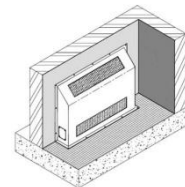

**CS0704 - Radiator Cover**  
(Price on application)



**CS0705 - Smoke-Detector Cover**  
£60.00



The Courtyard, Long Row, Newark, Notts NG24 1RW, ENGLAND

Telephone: +44 (0) 1636 610030 Fax : +44(0) 1636 610022

E-mail : [sales@gdmlindex.co.uk](mailto:sales@gdmlindex.co.uk) Website: [www.gdmlindex.co.uk](http://www.gdmlindex.co.uk)

## Ventilation Grilles

### Contents

- CS0701 Surface Mounted Vent Grille
- CS0702 Flush Mounted Vent Grille
- CS0703 Cast Iron Air Brick
- CS0704 Radiator Cover
- CS0705 Smoke Detector Cover



The Courtyard, Long Row, Newark, Notts NG24 1RW, ENGLAND  
Telephone: +44 (0) 1636 610030 Fax : +44(0) 1636 610022  
E-mail : [sales@gdmlindex.co.uk](mailto:sales@gdmlindex.co.uk) Website: [www.gdmlindex.co.uk](http://www.gdmlindex.co.uk)

## CS0701 - Surface Mounted Vent Grille

[CS701]

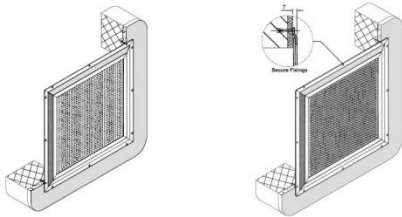

A surface mounted ventilation grille, primarily used within a designated cell unit. The grille offers a 17.9% free area for ventilation. Perforated to Home Office agreed dimensions to reduce ligature opportunities and restrict passing of contraband.

Complies with the Police Buildings Design Guide and Court Standard and meets the criteria for maintaining the highest level of security within the safe and secure environment of a Police Station, Magistrates or Crown Court, Prisons or HM Armed Forces.

### specification

- Constructed from 4mm thick grade 304 perforated stainless steel sheet welded within a 2mm thick zed section stainless steel frame with the corners of the frame rounded to reduce potential ligature attachment
- The grille is designed for surface mounting directly on top of masonry, render or tiling using tamper resistant screws
- 17.9% free area for ventilation

### finish

- Satin finish stainless steel, left natural

### options

- Almost any size available
- Can be provided in grade 316 stainless steel

# CS0701 - Surface Mounted Vent Grille

[CS701]

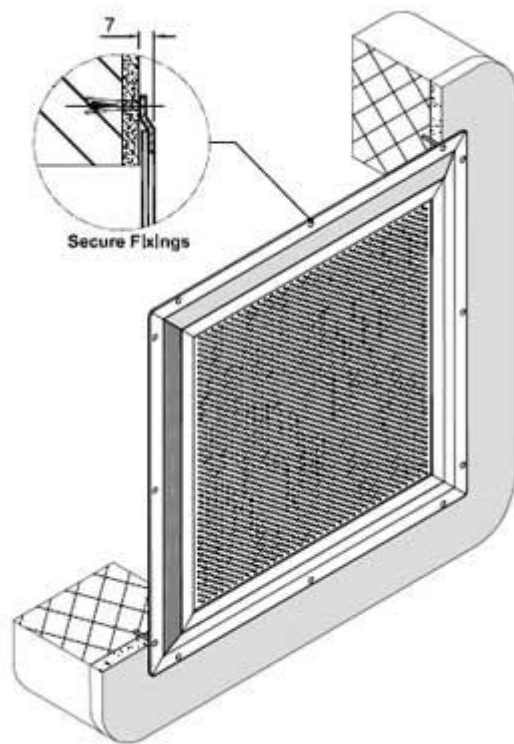
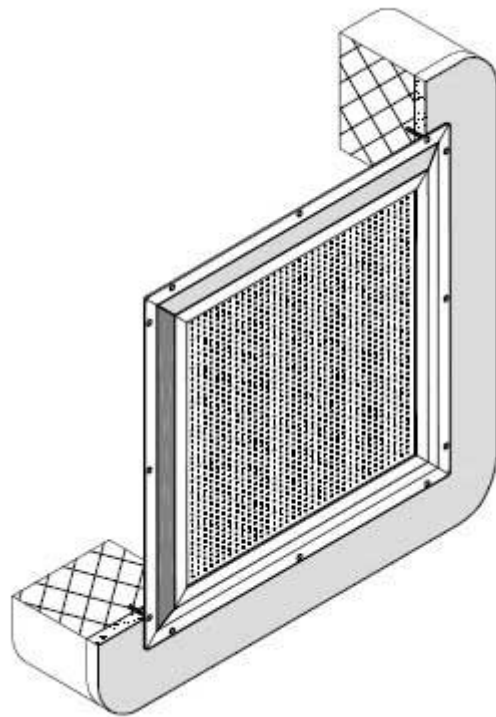



The Courtyard, Long Row, Newark, Notts NG24 1RW, ENGLAND  
Telephone: +44 (0) 1636 610030 Fax : +44(0) 1636 610022  
E-mail : [sales@gdmlindex.co.uk](mailto:sales@gdmlindex.co.uk) Website: [www.gdmlindex.co.uk](http://www.gdmlindex.co.uk)

## CS0702 - Flush Mounted Vent Grille

[CS702]

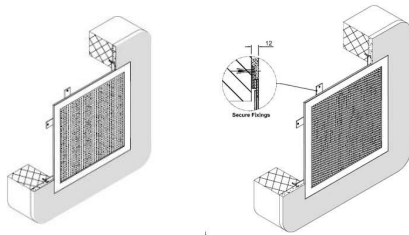

A flush mounted ventilation grille, primarily used within a designated cell unit. The grille offers a 17.9% free area for ventilation. Perforated to Home Office agreed dimensions to reduce ligature opportunities and restrict passing of contraband.

Complies with the Police Buildings Design Guide and Court Standard and meets the criteria for maintaining the highest level of security within the safe and secure environment of a Police Station, Magistrates or Crown Court, Prisons or HM Armed Forces.

### specification

- Constructed from 4mm thick grade 304 perforated stainless steel sheet welded within a 2mm thick zed section stainless steel frame with the corners of the frame rounded to reduce potential ligature attachment
- The grille is designed for flush mounting directly on top of masonry, render or tiling using tamper resistant screws
- 17.9% free area for ventilation

### finish

- Satin finish stainless steel, left natural

### options

- Almost any size available
- Can be provided in grade 316 stainless steel

# CS0702 - Flush Mounted Vent Grille

[CS702]

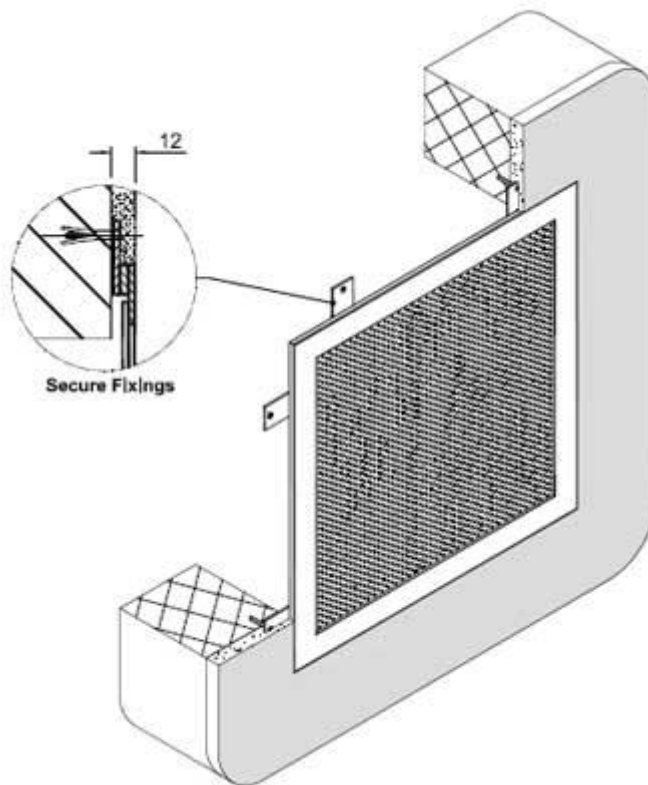
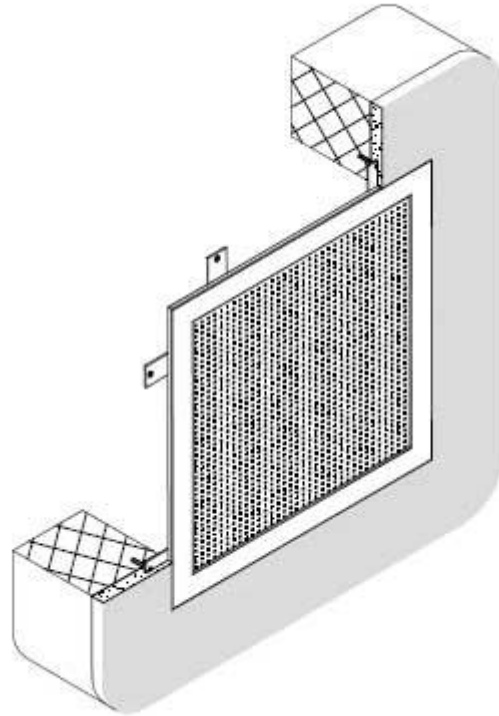



The Courtyard, Long Row, Newark, Notts NG24 1RW, ENGLAND

Telephone: +44 (0) 1636 610030 Fax : +44(0) 1636 610022

E-mail : [sales@gdmlindex.co.uk](mailto:sales@gdmlindex.co.uk) Website: [www.gdmlindex.co.uk](http://www.gdmlindex.co.uk)

## CS0703 - Cast Iron Air Brick

[CS703]

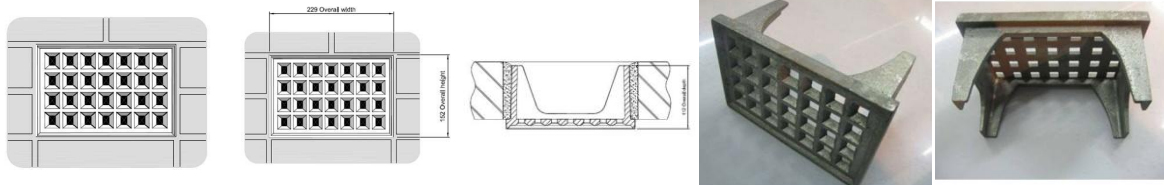

A cast iron ventilated air brick designed as an alternative to earthenware bricks and used in vulnerable locations, for use in Police Stations, Magistrates or Crown Courts, Prisons or HM Armed Forces.

### specification

- Constructed from cast iron, the unit is designed as an alternative to earthenware air bricks in vulnerable locations, for example at low level in exterior walls to provide ventilation below cell benches or in exercise yards

### finish

- Satin finish stainless steel, left natural

### options

- Non-available

# CS0703 - Cast Iron Air Brick

[CS703]

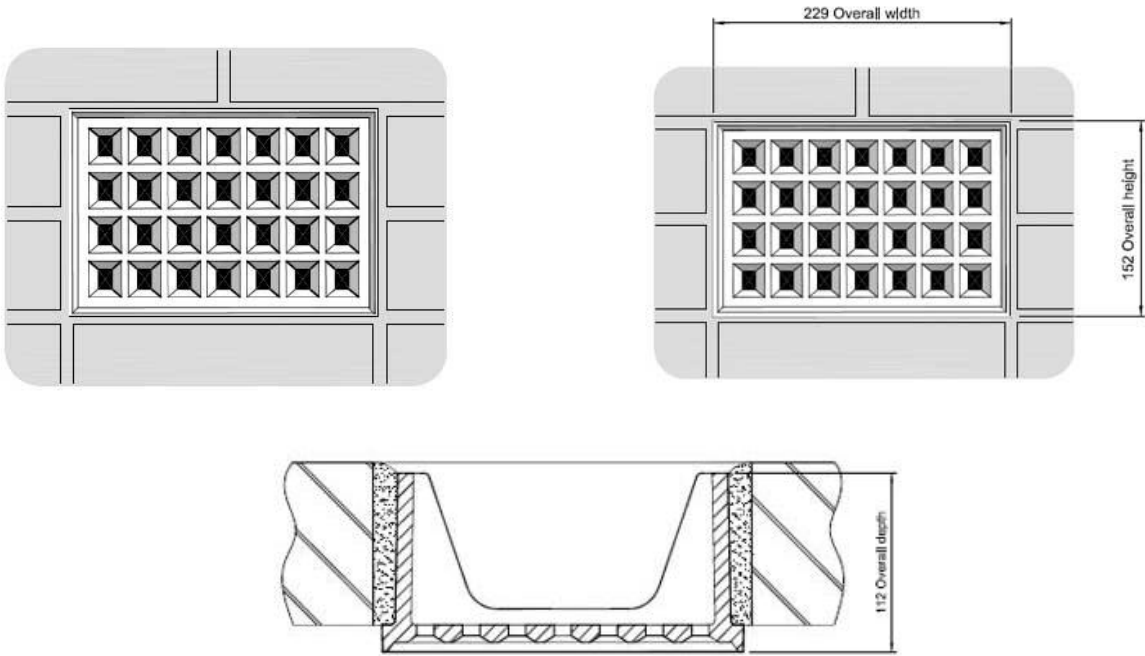



The Courtyard, Long Row, Newark, Notts NG24 1RW, ENGLAND  
Telephone: +44 (0) 1636 610030 Fax : +44(0) 1636 610022  
E-mail : [sales@gdmlindex.co.uk](mailto:sales@gdmlindex.co.uk) Website: [www.gdmlindex.co.uk](http://www.gdmlindex.co.uk)

## CS0704 - Radiator Cover

[CS704]

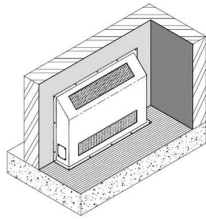

A ventilated surface mounted steel radiator cover, manufactured and mounted directly over the radiator. Fixed via tamperproof security screws, for use in Police Stations, Magistrates or Crown Courts, Prisons or HM Armed Forces.

### specification

- Constructed from 3mm thick mild steel sheet with perforated areas from 2mm thick grade 304 stainless steel
- Designed to be surface mounted directly on top of masonry, render or tiling
- The 2mm diameter holes in the perforated areas offer 22.7% free area for air transfer, whilst restricting the passage of contraband. All corners are rounded to prevent ligature attachment

### finish

- One coat factory applied primer to mild steel, stainless steel left natural

### options

- Manufactured fully from stainless steel
- Polyester powder coated
- Any size or shape available
- Matching pipe covers as required

# CS0704 - Radiator Cover

[CS704]

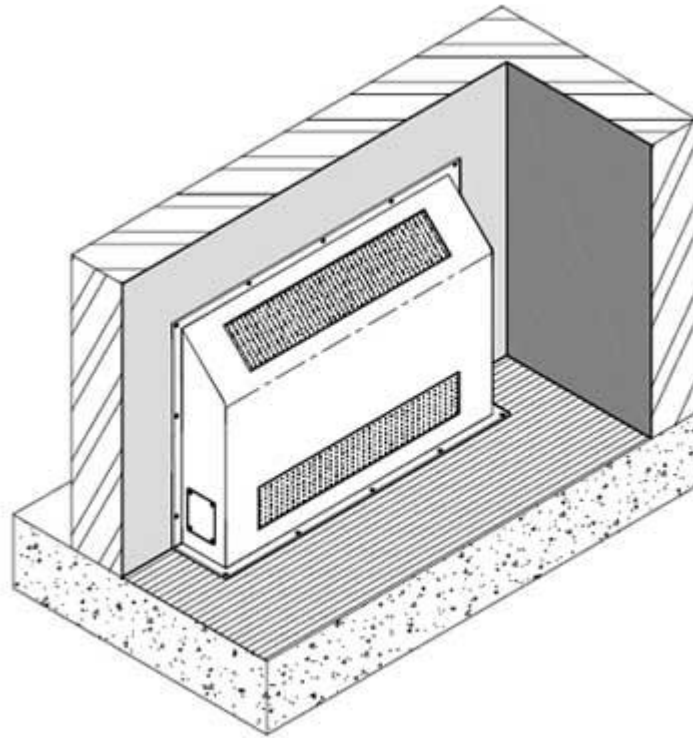



The Courtyard, Long Row, Newark, Notts NG24 1RW, ENGLAND

Telephone: +44 (0) 1636 610030 Fax : +44(0) 1636 610022

E-mail : [sales@gdmlindex.co.uk](mailto:sales@gdmlindex.co.uk) Website: [www.gdmlindex.co.uk](http://www.gdmlindex.co.uk)

## CS0705 - Smoke-Detector Cover

[CS0705]

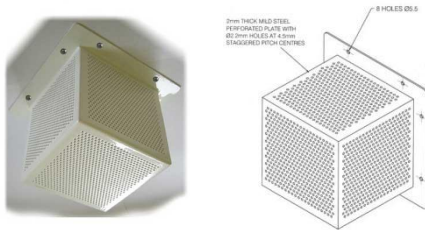

**For usage in corridor or reception area's only.**

**This product is still awaiting home office approval and shouldnt be used in prison cells..**

A surface mounted smoke-detector cover made from perforated mild steel and offering protection to otherwise vulnerable parts. Perforations to Home Office required dimensions and arrangement for ventilation holes.

NOTE: Security Fixings Included

### specification

- Constructed from 2mm thick perforated mild steel with 2mm holes and rounded corners
- Designed for surface mounting directly on top of render using tamper resistant screws
- SIZE: H140mm x W140mm x D140mm (H190mm x W190mm including flange)

### finish

- Powder coated in white

### options

- Other powder coating colours available on request
- Other sizes available on request

# CS0705 - Smoke-Detector Cover

[CS705]

